

## SPECIFICATION FOR APPROVAL

### Cavity Directional Coupler

Part Number	Coupling/Nominal Input←→P2	Inband Ripple	Insertion Loss
SS-CP0827A-5	-5dB	±0.8dB	≤2.1dB
SS-CP0827A-6	-6dB	±0.8dB	≤1.6dB
SS-CP0827A-7	-7dB	±0.8dB	≤1.5dB
SS-CP0827A-8	-8dB	±0.8dB	≤1.2dB
SS-CP0827A-10	-10dB	±1.0dB	≤0.8dB
SS-CP0827A-15	-15dB	±1.0dB	≤0.4dB
SS-CP0827A-20	-20dB	±1.0dB	≤0.22dB
Operating Frequency	800-2700MHz		
VSWR Input(all ports)	≤1.20		
Directivity	≥20dB		
Impedance	50 Ohm /Nominal		
Power(max)	200W(average.), 1.5KW(peak)		
Operating Temperature	-25 ~ +75°C		
Connector Input & Output	N Female		
Housing Material	Aluminum		
Connector Material(Body)	Brass		
Connector Plating	Inner: Ag or Au; Outer: Ni or Tri-metal		

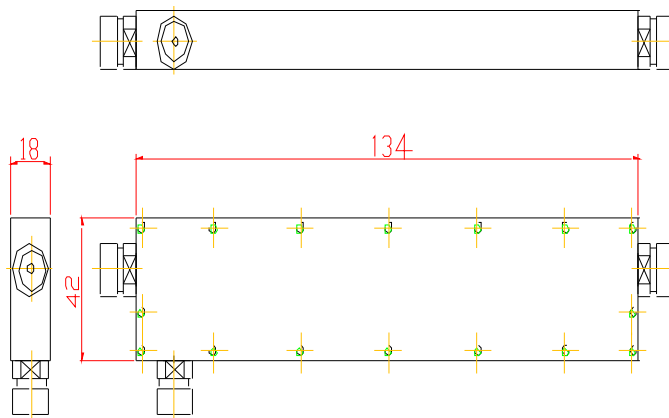

Outline Drawing(Unit:mm)